







Charlotte

{ Part 1 - Small Square }

Charts

© Dedri Uys 2016. All Rights Reserved.

Stitch Legend

•	Sl st – Slip stitch 引き抜き編み		Tr – Treble crochet 長々編み
○	Ch – Chain 鎖編み		Fpdc – Front post double crochet 〈表引き上げ編み〉長編み
+	Sc – Single crochet 細編み		FPdtr – Front post double treble crochet 〈表引き上げ編み〉三つ巻き長編み
T	Hdc – Half-double crochet 中長編み		Fpdc2tog – Front post Dc 2 together 〈表引き上げ編み〉長編み2目一度
T	Dc – Double crochet 長編み		

Round 1 (Colour A)

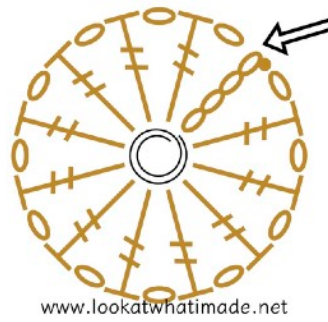

Round 2 (Colour A)

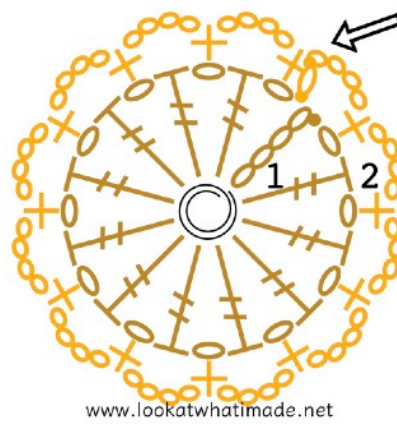

Round 3 (Colour B)

編みはじめはスタンディング長編みにします。

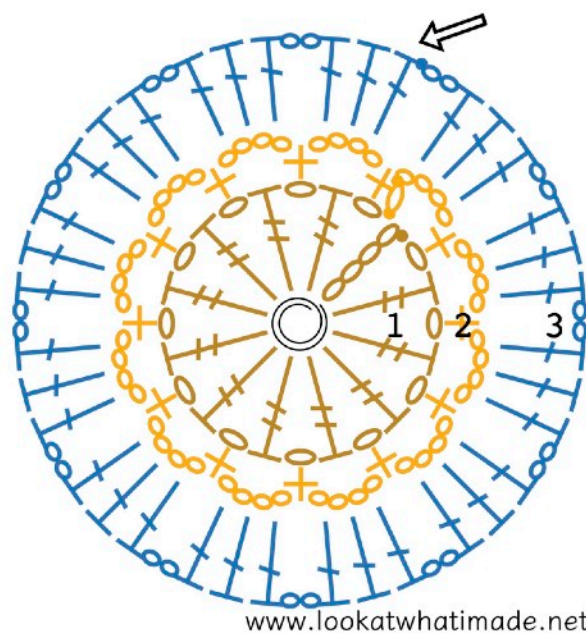

Round 4 (Colour B)

立ち上がりの鎖2目は1目としてカウントしません。

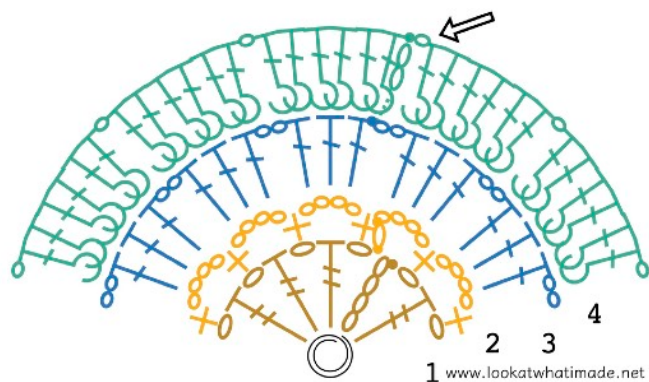

Round 5 (Colour A)

3段目の鎖2目と4段目の鎖1目の両方に長編みを編み入れます。

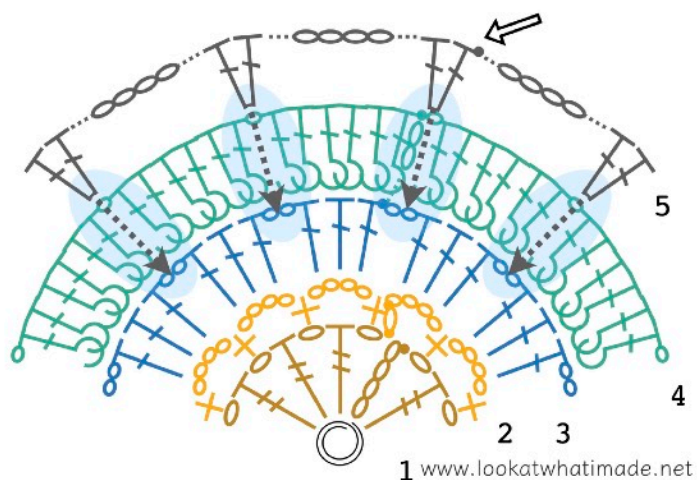

Round 6 (Colour B)

5段目の鎖編みには編みません。

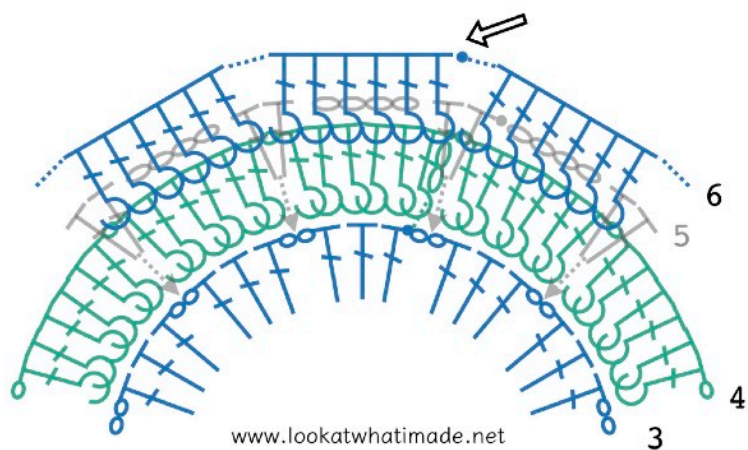

Round 7 (Colour B)

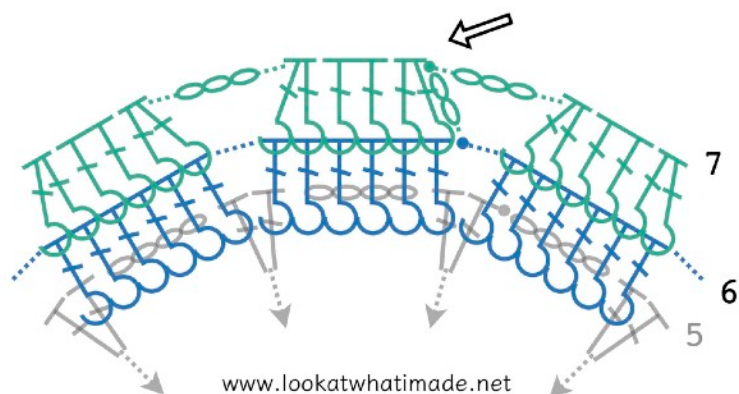

Round 8 (Colour A)

5段目の長編み2目の間に長編みを編み入れます。このとき、手前側にある6段目の長編みの花びらの間（7段目の鎖3目の下にあります）からかぎ針を入れ、7段目の鎖3目を覆うように編みます。5～7段目の3段をまとめて編むので花びらが盛り上がってきます。

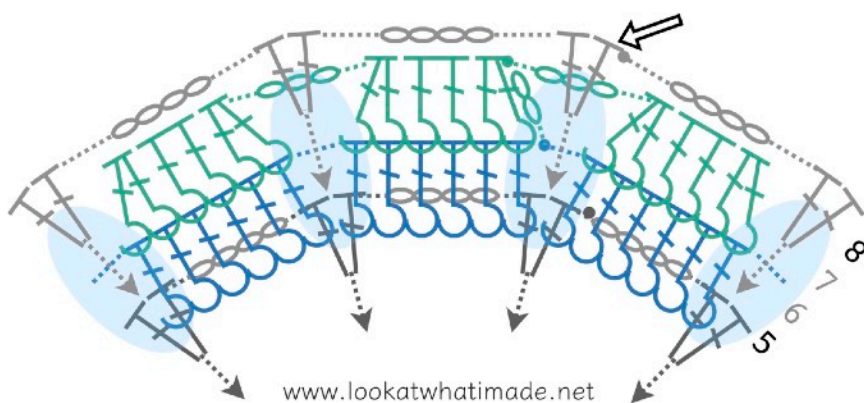

Round 9 (Colour B)

8段目の鎖編みには編みません。

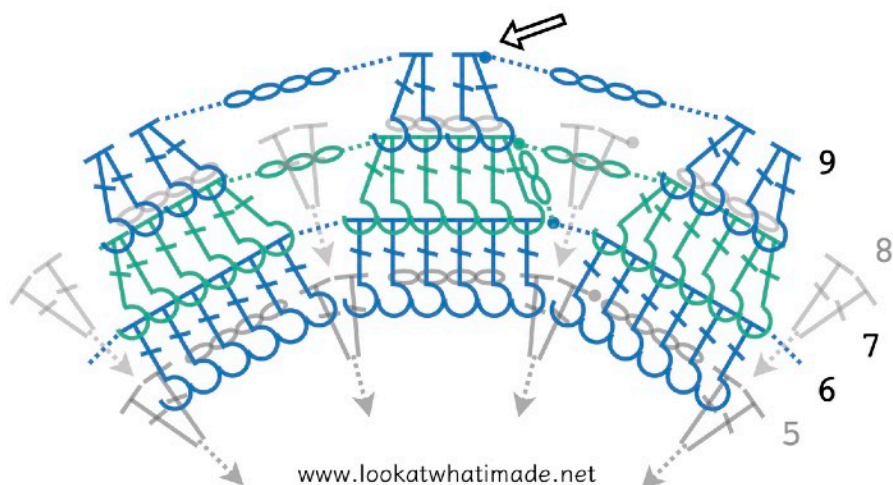

Round 10 (Colour A)

8段目の長編み2目の間に長編み5目を編み入れます。このとき、9段目の鎖4目を覆うように編みます。

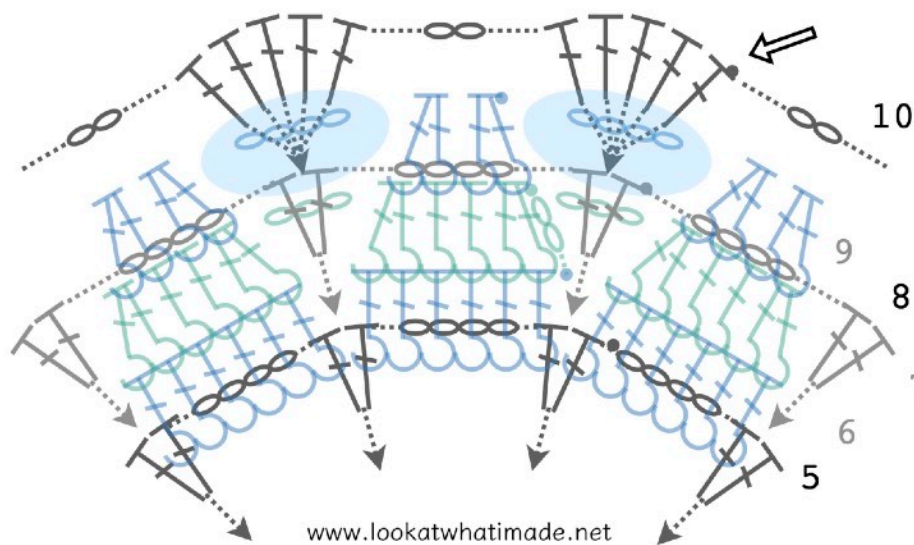

Round 11 (Colour B)

10段目の鎖編みには編みません。

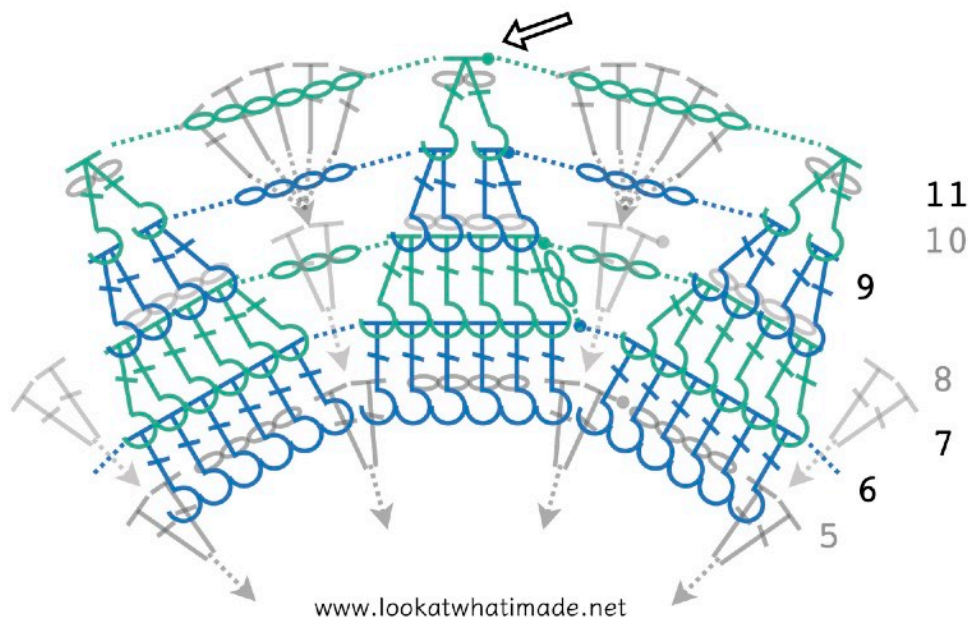

Round 12 (Colour A)

11段目の鎖6目をモチーフの後ろ側に移動しておきます。10段目の長編み5目と8段目の長編みに編みます。

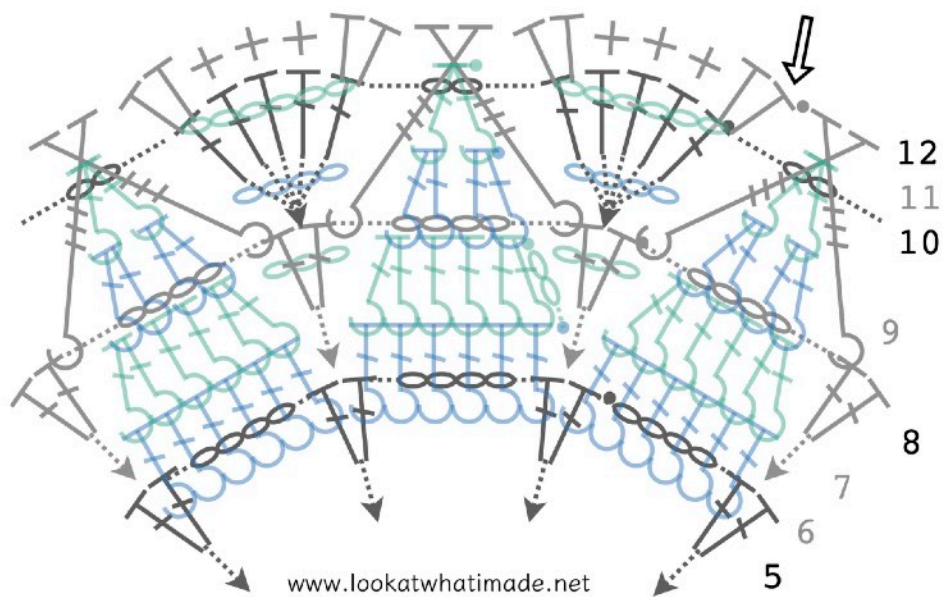

Round 13 (Colour A)

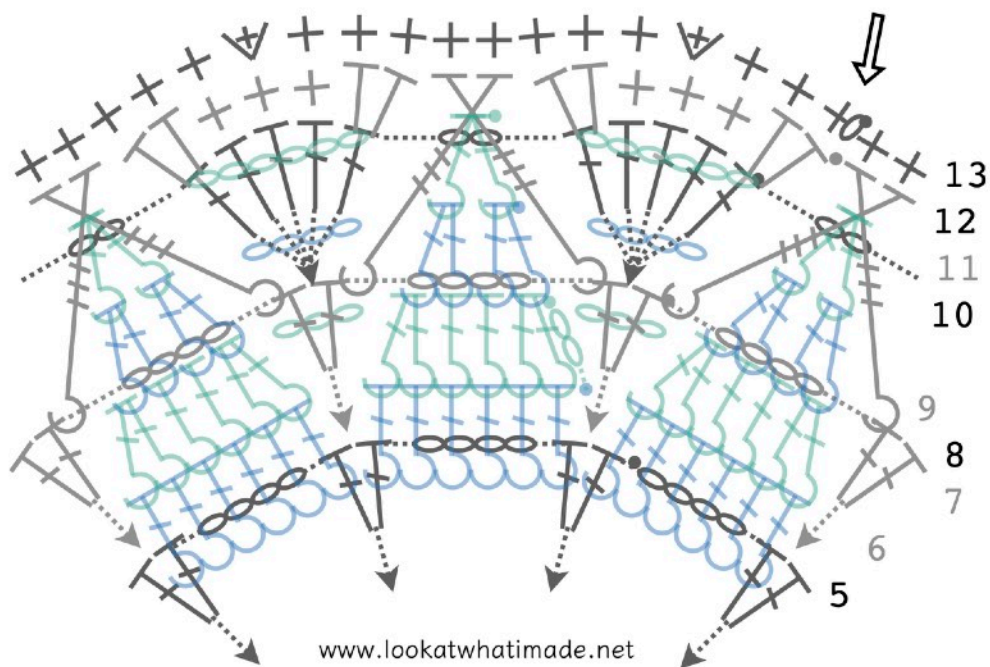

Round 14 (Colour A)

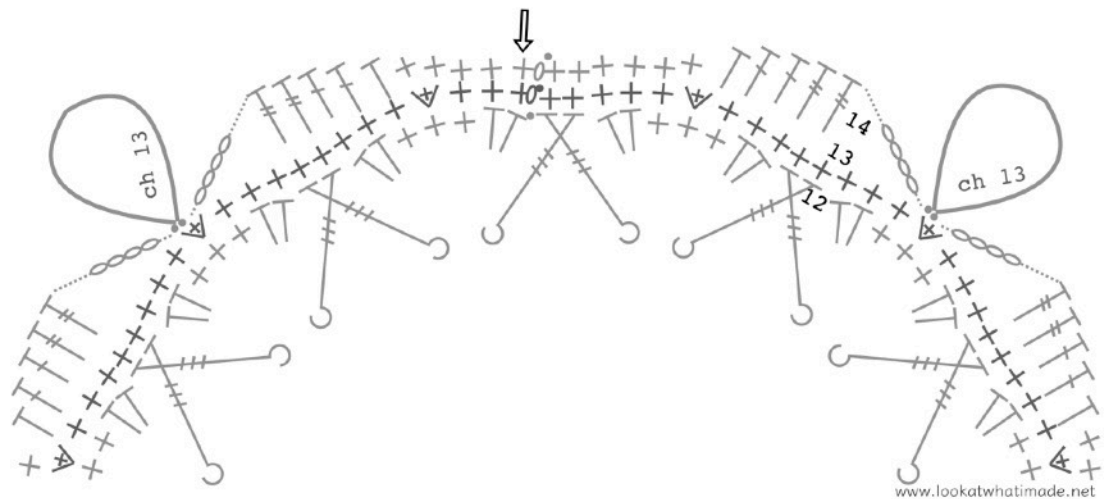

Round 15 (Colour A)

コーナーの細編みは鎖13目に編み入れます。

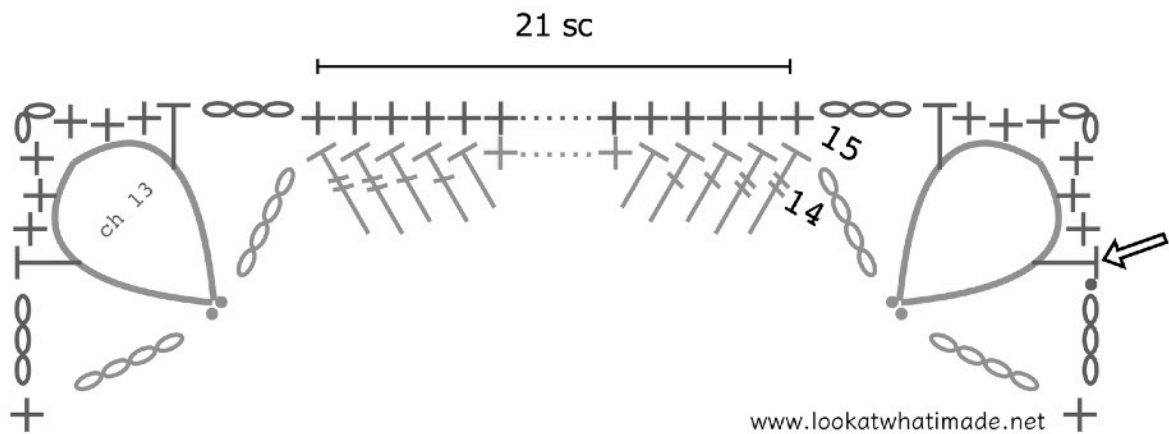

Round 16 (Colour B)

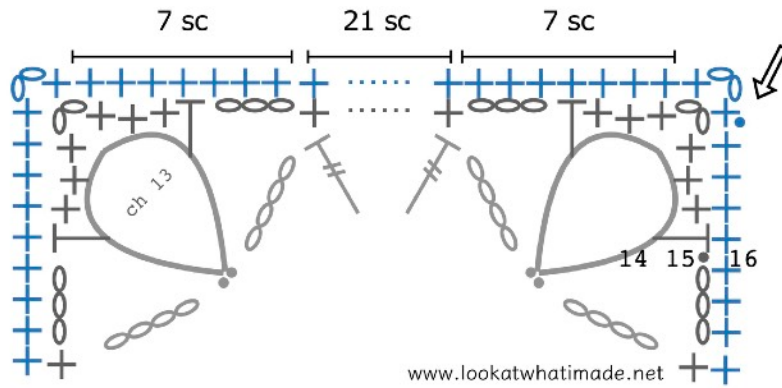

Round 17 (Colour B)

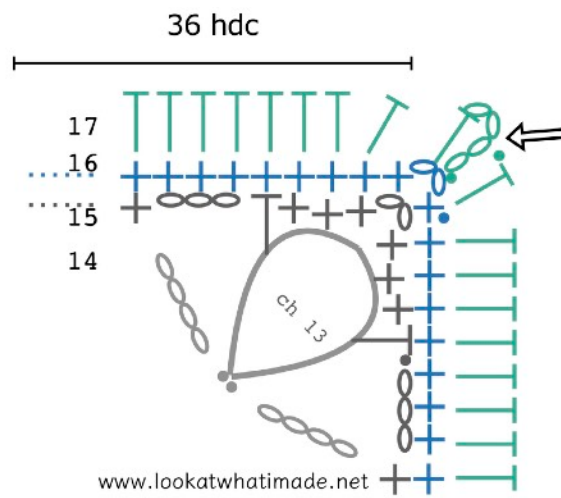

Round 18 (Colour A)

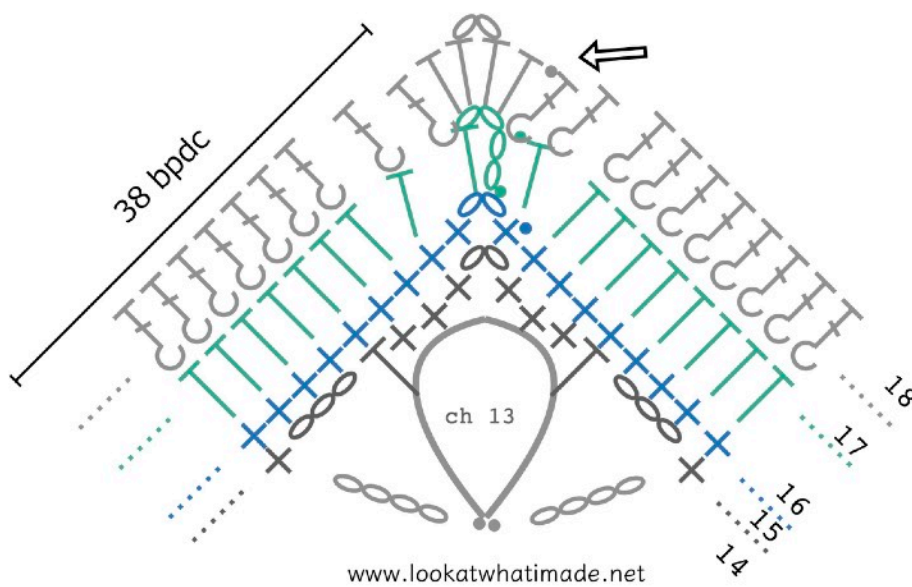

Charts created by Masako K (Nov 25, 2020)